



FKK Corporation

PELLET IGNITER

2018 Catalog

Alumina ceramic high temperature igniter

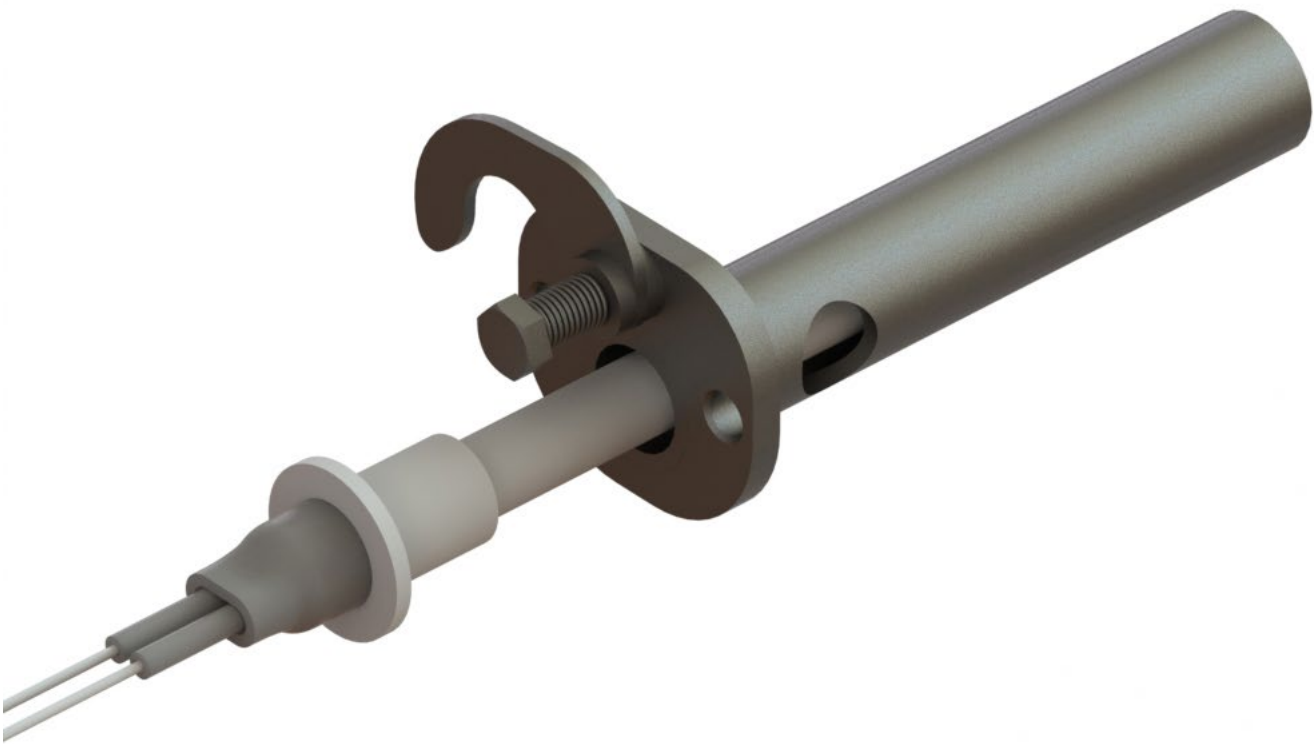

**A revolutionary way to ignite
biomass and wood pellet**



FKK Corporation

Eco solution

Fast Lighting



With a time to ignition of 60~90 seconds (according to burner) at 300W, PSx series alumina ceramic igniters are the most performant ignition system to light wood pellet, wood chips or other biomass.

Made to last

100,000 cycles pass

PSx alumina ceramic igniters are made to last for good and reduce maintenance. This type of igniter have pass 100,000 cycles test and some are in use in pellet stove for more than 15 years.

Reduce emission



Thanks to high surface temperature of 950~1000°C it allow high temperature of combustion and thus burn combustion residues more efficiently and reduce harmful emission.

Original technology

Since 80's

FKK Corporation has the longest history and experience of producing alumina tube igniters. The company first production back from 80's for solid fuel and kerosene heater industry in Japan.

Japan quality



All PSx alumina ceramic igniters are 100% made in Japan with components from Japanese company. Besides, the PSx igniters are fully complying with TUV Rheinland company's testing.

Wide range

30+ models

PSx ceramic igniters for biomass and wood pellet ignition count now more than 30 different models and can easily be customized according to your requirements for wiring and ceramic flange.

Biomass hot surface igniters

Wood pellet, wood chips and biomass hot surface ignition components

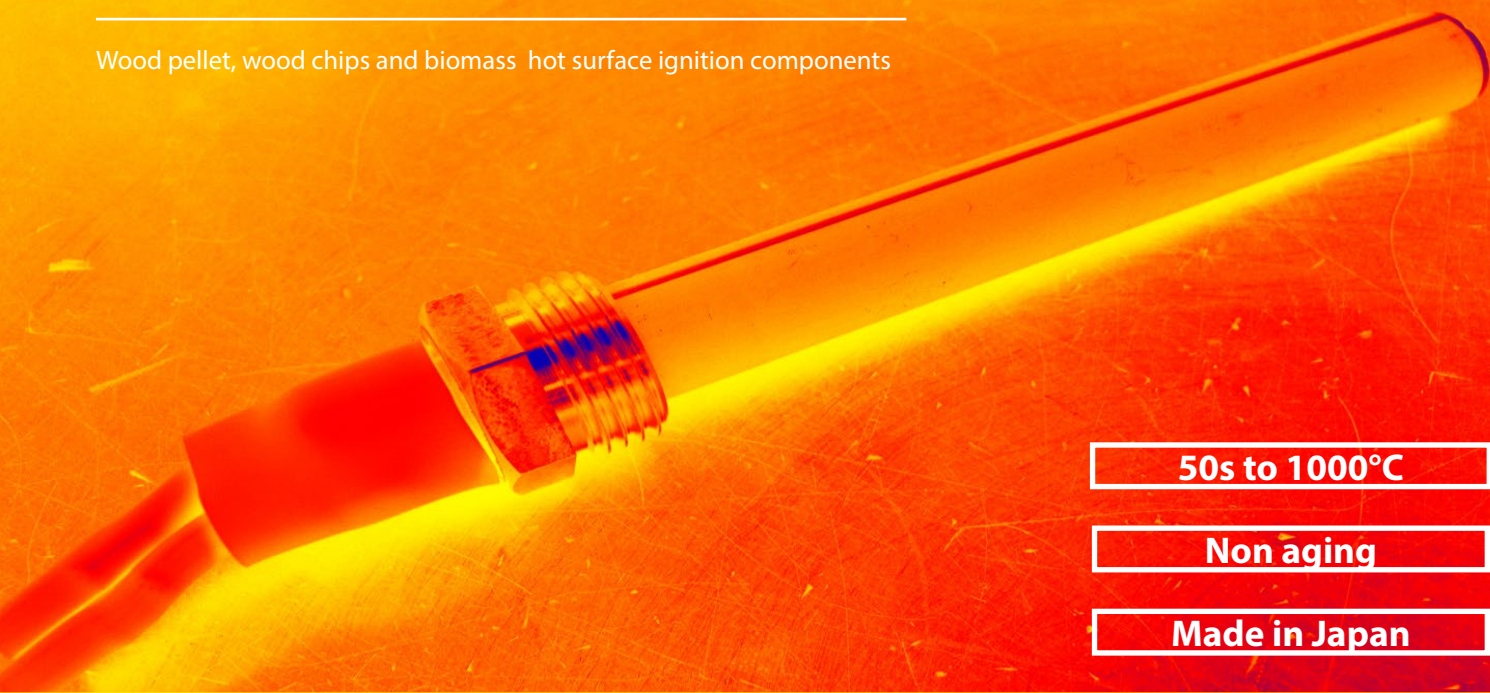

50s to 1000°C

Non aging

Made in Japan

Introducing the PSx[®] series ceramic biomass igniters range, an advance in ignition technology for solid fuels.

FKK Corporation specialises in ceramic hot surface igniters and has many years of experience of working closely with customers to develop bespoke solutions for innovative appliances manufacturers. We are a trusted supplier of hot surface igniter products to many biomass/pellet stoves, burners and boilers manufacturers.

These advanced igniters are simply the best for lighting wood pellet and biomass burners. They use only a fraction of the energy required by hot air fans and ignition blowers and will light all fuel types. Ideal for wood pellets, wood chips, lot, corn, maize, etc.

With a considerably higher temperature, around twice that of traditional metal sheathed products, ignition times are reduced to as little as 60 seconds. This makes them significantly more economical in use.

All our range can be customized to fit perfectly in your appliance.

Ceramic ignition technology benefits

- A fraction of the energy consumption compared to conventional heater
- Long lasting (non aging)
- Time to ignition 60~90 seconds
- Tested to 100,000 cycles, used for long time in Japanese market (15 years)
- Easy to install and retrofit
- Fits any steel tube with an inner diameter of $\geq 18\text{mm}$
- 1000°C at steady-state temperature
- Cannot overheat even with blower failure
- Available in 100V / 120V / 220V / 240VAC
- Fully electrically insulated with no exposed electric contacts
- UL/CE certified wiring (200 to 500°C heat resistant wire)
- Impervious to oxidation and corrosion
- Ignite wood pellet, wood chips, split logs, straw and other biomass
- Comply with RoHS, REACH regulation on Hazardous Substances

Systems

- Wood pellet stove
- Wood pellet boiler
- Wood pellet burner
- Wood chips burner
- Straw burner
- Other biomass burner

Certification

- TUV Rheinland - EN 60335
- TUV Rheinland - RoHS



A revolutionary way to ignite biomass

PSx series igniters revolutionize biomass heating appliances ignition process. FKK developed several types to fit in every appliances.

Tubular radiant structure type (Blowing air system: PSx-2 /PSx-7) ceramic igniters have a through hole that let air through the heating element body. With this structure, ignition performance can be increase by 1.4 times compare to metal cartridge heater.

External radiant structure type (PSx-1 / PSx-6) ceramic igniter heat the surround air for indirect ignition of pellet. These models are economical and more easy to install into airtight systems.

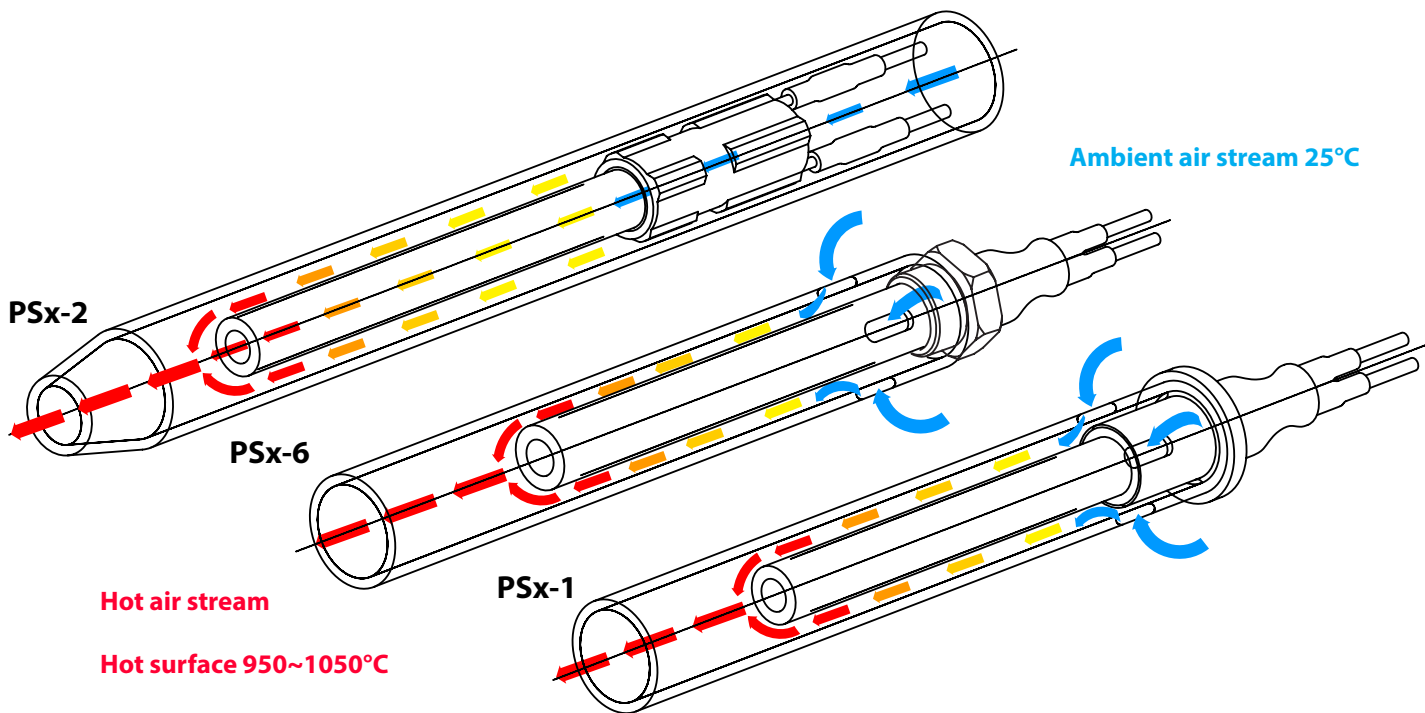

Rising surface temperature

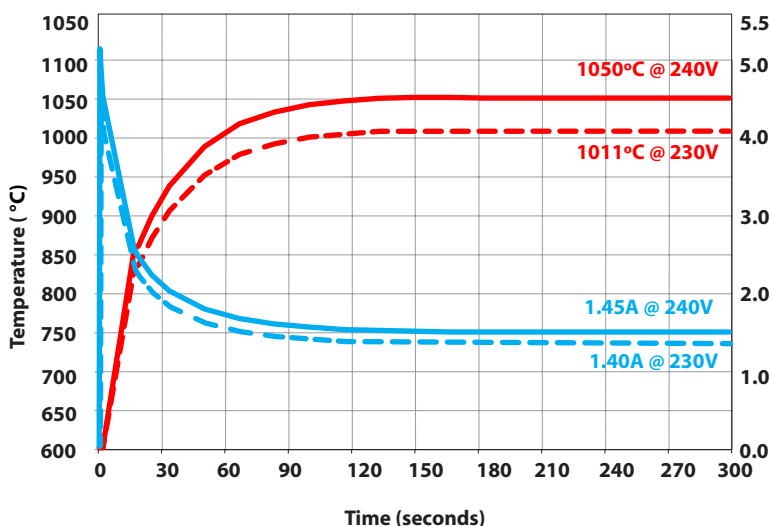

Nominal resistance: 44.64Ω
 Inrush current: 5.05A (@240V/60Hz)
 Current: 1.45A (@240V/60Hz)

Heat distribution

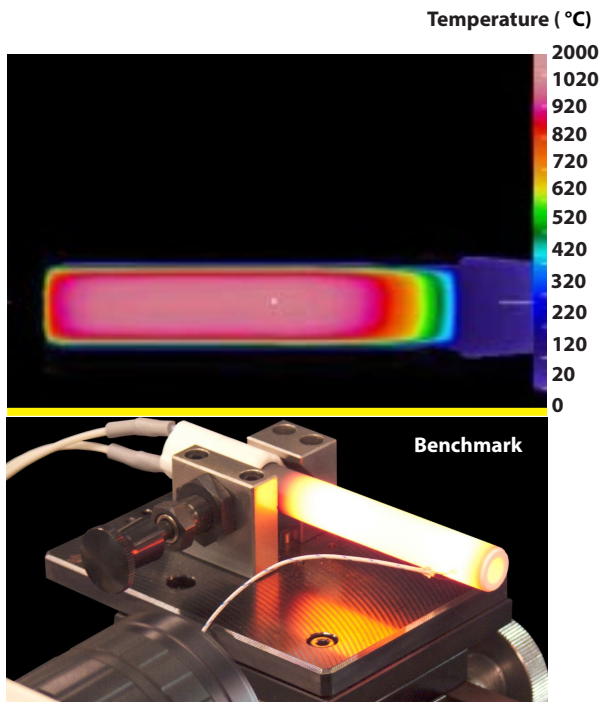

PSx series igniters line up

A simple and efficient solution for biomass ignition

Application

Heaters suitable for ignition of biomass, wood pellet, wood chips, wood log, for stoves, boilers and burners.

Features

- Tested to 100,000 ON/OFF cycles.
- Fast ignition time (60~90s to ignite pellet according to burner)
- Wiring available in UL or CE certified version.
- Totally customizable solution, many design available
- 240W and 300W type
- Available in 120V , 230V, 220~240V

Line up

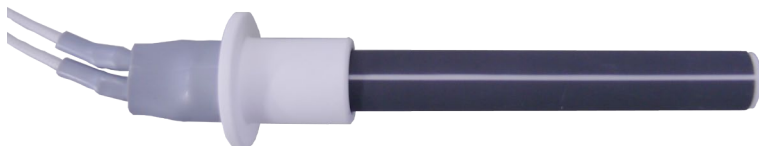

PSx-1

26mm ceramic flange
Radiant type

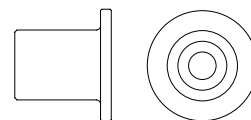

PSx-2

17.7 mm ceramic flange
Tubular structure type (Blowing air)

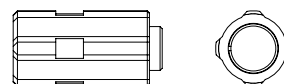

PSx-3 / PSx-4

No flange, perfect retrofit solution
Blowing air or radiant type available



PSx-6 / PSx-7

G3/8" threaded flange fixed on heater
Blowing air or radiant type available

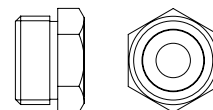

All drawings and data-sheets are available for download at : www.plug.fkk-corporation.com/en/download
You can also scan the QR code to go directly on the related page.

This catalog is also available in BG / DE / ES / FR / GR / IT / JP / KR / NL / PL / RU language.



Line up

Unit (mm)

300W Class - Black coating alumina heaters (B)



240W Class - White coating alumina heaters (W)

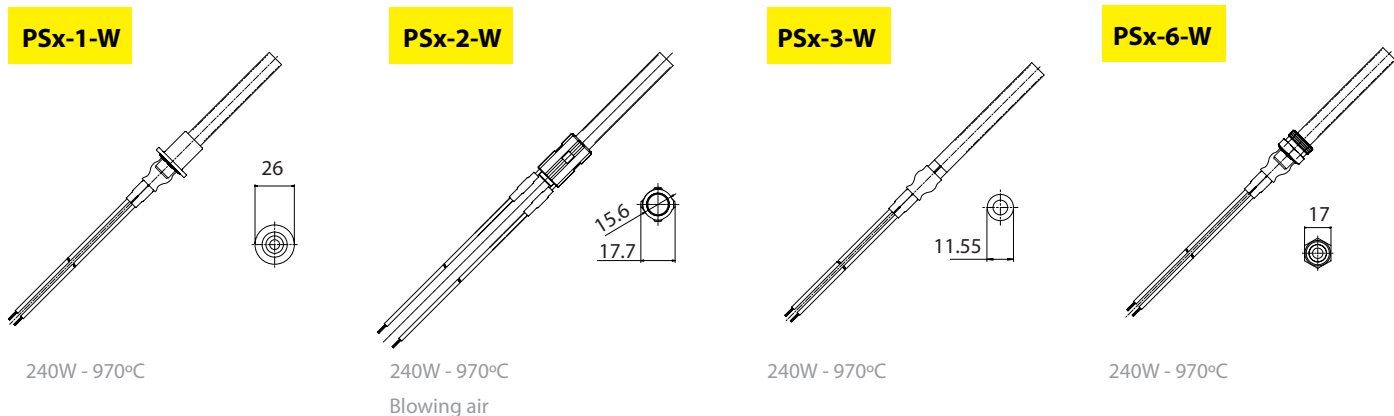

Type	Reference	Flange type	Heater length (mm)	Available voltage (V)	Cable length (mm)
300W	PSx-1-240-B	Ceramic 26mm	107	220~240V	350mm *All lengths available upon request
	PSx-2-240-B	Ceramic bushing 17.7 mm	113	220~240V	
	PSx-3-240-B	Flange less - Retrofit	107	220~240V	
	PSx-4-240-B	Flange less - Retrofit	107	220~240V	
	PSx-5-240-B	G1/2" flange 23mm	107	220~240V	
	PSx-6-240-B	G3/8" flange 17mm	107	220~240V	
	PSx-7-240-B	G3/8" flange 17mm	107	220~240V	
240W	PSx-1-120-W	Ceramic 26mm	107	120V	
	PSx-2-120-W	Ceramic bushing 17.7 mm	113	120V	
	PSx-3-120-W	Flange less - Retrofit	107	120V	
	PSx-6-120-W	G3/8" flange 17mm	107	120V	

FKK corporation

www.plug.fkk-corporation.com

Head office / Sales

11 Tsutsumisoto-cho Kisshoin
Minami-ku, 601-8399 Kyoto, Japan

International department
TEL +81(0)75-314-8760
FAX +81(0)75-314-4167
international@fkk-corporation.com



Distributors

Europa territories main distributor

Mercobel B.V.A
Moerenakker 44 BE-9070 Destelbergen, Belgium
TEL+32 (0) 9 232 49 75 FAX +32 (0) 9 230 18 02
info@mercobel.be - www.mercobel.be

Canada / USA main distributor

Crystal Technica Ltd.
11b Depot Street, South Grafton, Massachusetts, 01560, USA
TEL +1 508 839 0013 FAX +1 508 519 0397
info@crystaltechnica.com - www.crystaltechnica.com

Russia main distributor

FKK Corporation Russia
Reshetnikova str.15, office 118, St. Petersburg, 196105, Russia
TEL +7 812 360 83 45 FAX +7 812 709 08 43
dt@fkk-corporation.ru - www.fkk-corporation.ru

South Korea main distributor

Samson Corporation
Guro 3dong Guro-gu, Seoul,152-775, South Korea
TEL +82 - 2 - 895 - 6011 FAX +82 - 2 - 2025 - 1115
hspark@samsonmed.co.kr